

DIMENSIONAL DATA

SIZE IPS	TRUE O.D.	A	B	C MIN. WALL	D MIN. WALL	E MIN. WALL
16x12	16.00	11.00	36.00	2.25	1.42	1.78

CUSTOM LENGTH "A": _____

CUSTOM LENGTH "B": _____

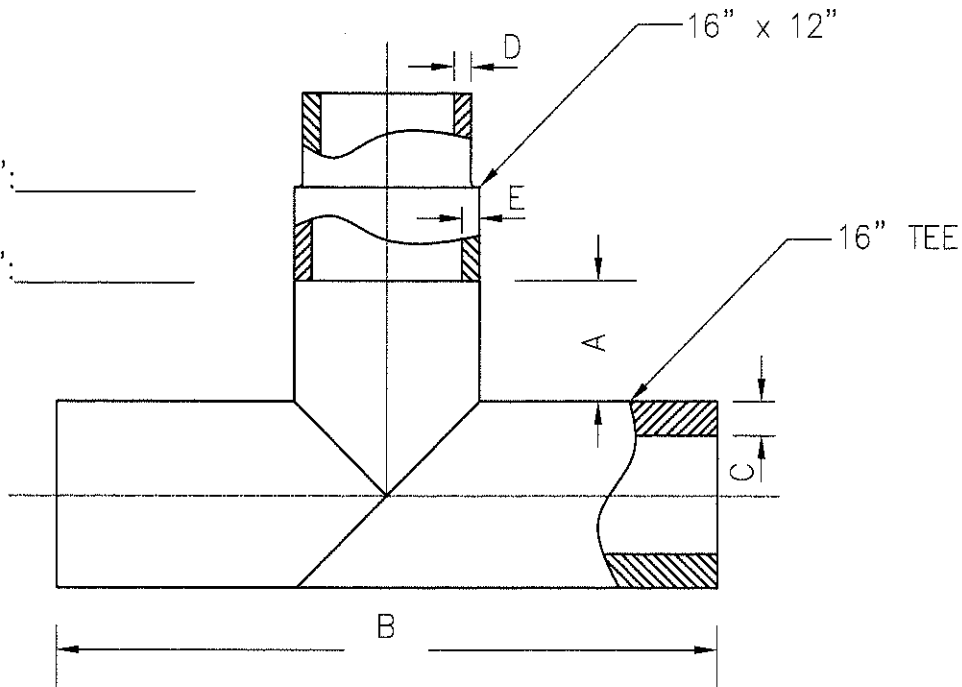

NOTES

1. TOLERANCES +/- 5.0" FOR DIMENSION "A" & "B" ONLY.
2. ANGLE TOLERANCES +/- 2.0'.
3. CLASS 200 - SDR.9 RATED.
4. REF. "C, D, & E" MINIMUM WALL THICKNESS.
5. USE SDR.7 PIPE, SDR.9 REDUCERS.
6. ENDS COUNTERBORED IF REQUESTED.
7. USE APPROVED VENDORS.
 - WL
 - INDEPENDENT PIPE
8. FOLLOW SECOR FUSION PROCEDURES.
9. FOLLOW SECOR QUALITY PROCEDURES.
10. NOTIFY FM APPROVALS OF CHANGES.
11. CUSTOM DESIGN AVAILABLE.

SECOR

17321 GROESCHKE ROAD HOUSTON, TX. 77084
PH. # 281-556-1661 FAX# 281-556-1683

16 x 12 REDUCING TEE
CLASS 200

CONFIDENTIAL NOTICE / CONTROLLED DOCUMENT

Dissemination of this information contained herein is prohibited

DATE:	DRAWN BY:	CHECKED BY:	DWG. NO.	REV.
6/19/10	CRAIG STEVENS	DAVID NIX	SEC-513-16/12-200	B